



# Fairy Lights Quick Connect System

24V LED / COMMERCIAL GRADE



INDOOR  
OUTDOOR



UV  
STABILISED



24V EXTRA  
LOW VOLTAGE



OUTDOOR  
IP RATED



2 YEAR  
WARRANTY



COMMERCIAL  
GRADE



VANDAL  
RESISTANT



GREEN  
FRIENDLY



AUSTRALIAN  
DESIGNED

# Fairy Lights



**FIREFLY LIGHTING**

Phone : +61 7 3254 4333

Email : sales@fireflylighting.com.au

Address : 9/29 Links Ave. North Eagle Farm,  
Brisbane QLD 4009 Australia

[www.fireflylighting.com.au](http://www.fireflylighting.com.au)

**PRODUCT RANGE**

**24V LED STRAIGHT STRING**

**COMMERCIAL GRADE / QUICK CONNECT SYSTEM**

Firefly Fairy Lights are the ideal solution for many applications. Straight strings come in 5m and 10m lengths. Simply connect and install. No need for cutting, soldering, or taping, saving you time and expensive labour costs.

**Golden Warm White Static Range**

FL-GW-5-WH

Golden warm white

FL-GW-5-BL

Golden warm white

FL-GW

Golden warm white

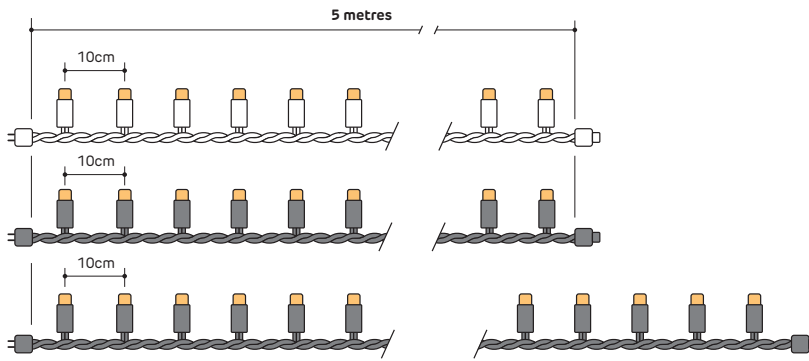

WHITE cable and LED base



BLACK cable and LED base



**Colours Static Range**

FL-CW

Cool white

FL-R

Red

FL-B

Blue

FL-MC

Multi coloured

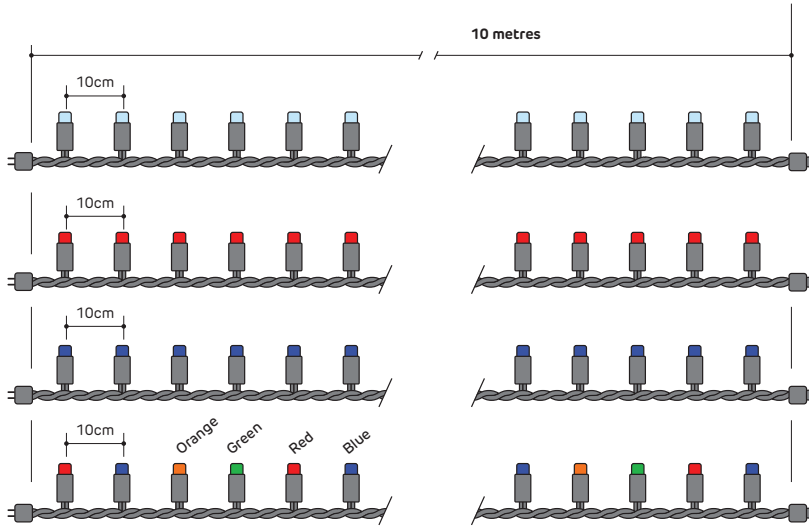

**Glitter Range**

FL-GW-1F

Golden warm white static with cool white glitter

FL-FO-2F

Golden warm white glitter

FL-FO-3F

Golden warm white glitter with cool white glitter

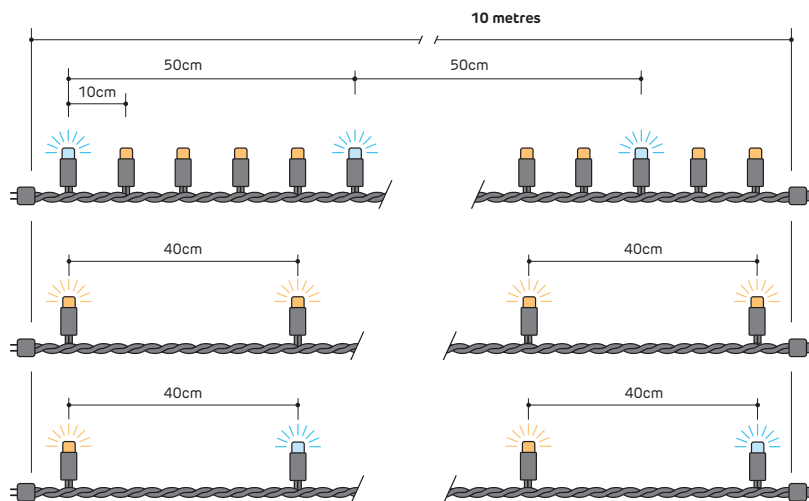

# Fairy Lights



**FIREFLY LIGHTING**

Phone : +61 7 3254 4333

Email : sales@fireflylighting.com.au

Address : 9/29 Links Ave. North Eagle Farm, Brisbane QLD 4009 Australia

[www.fireflylighting.com.au](http://www.fireflylighting.com.au)

## SPECIFICATIONS

24V LED STRAIGHT STRING

COMMERCIAL GRADE / QUICK CONNECT SYSTEM



Firefly Lighting Quick Connect System makes light work of creating spectacular architectural lighting effects. Made stronger and robust for Australia's extreme weather conditions, the Firefly Lighting Quick Connect System is designed to provide you with greater creative flexibility while significantly reducing the time and labour required for installation. The Quick Connect System is only limited by your imagination, and is fully interchangeable with our Fairy Light Straight String and Icicle String ranges.

Range	Golden Warm White			Colours				Glitter			
<b>PRODUCT ID</b> PRODUCT CODE	FL-GW-5-WH FL-G2-5M-10CM -24VDC-W-GWW	FL-GW-5-BL FL-G2-5M-10CM -24VDC-B-GWW	FL-GW FL-G2-10M-10CM -24VDC-B-GWW	FL-CW	FL-R FL-G2-10M-10CM -24VDC-B-RED	FL-B FL-G2-10M-10CM -24VDC-B-BLUE	FL-MC FL-G2-10M-10CM -24VDC-B-RBOG	FL-GW-1F FL-G2-10M-10CM -24VDC-B-GWW/CWF	FL-FO-2F FL-G2-10M-40CM -24VDC-B-GWWF	FL-FO-3F FL-G2-10M-40CM -24VDC-B-GWWF/CWF	
<b>Colour Designation</b>											
	Golden Warm White			Cool White	Red	Blue	Multi Colour: Orange, Green, Red, Blue	Golden Warm White Static + Cool White Glitter	Golden Warm White Glitter	Golden Warm White Glitter + Cool White Glitter	
<b>String length metres</b>	5m		10m								
<b>Quantity of LEDs per string length</b>	50		100							25	
<b>LED Spacing</b> ( see page 2 )	Standard							Glitter Spacing			
<b>Cable Colour</b>	White   Black										
<b>Net Weight per piece</b>	0.5 kg		1.0 kg								
<b>Dimmable</b>	Yes (with dimmable PWM driver)							No			
<b>CCT</b>	2200K			6500K	Various						
<b>Power watts / string length</b>	2.5W		5W	4W	3.2W	4W				1.6W	
	<b>Cable</b> 1 x 0.50mm, 1 x 0.75mm Quick Connect System / <b>Voltage</b> 24 V DC / <b>LED Cap</b> Clear / <b>IP Rating</b> IP65										

## DIMENSIONS

Shown in millimetres

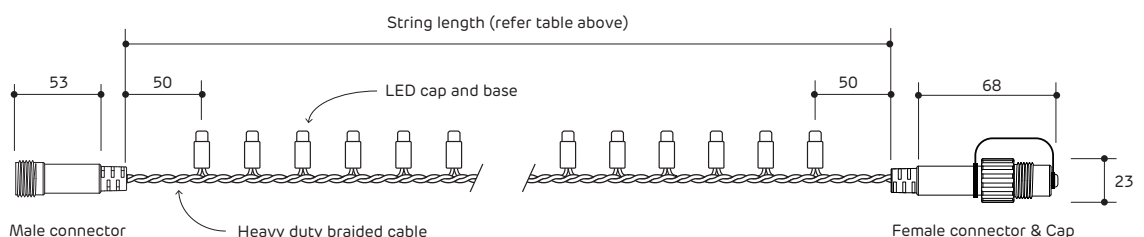

# Icicle Lights

## PRODUCT RANGE

24V LED ICICLE STRING

COMMERCIAL GRADE / QUICK CONNECT SYSTEM



**FIREFLY LIGHTING**

Phone : +61 7 3254 4333

Email : sales@fireflylighting.com.au

Address : 9/29 Links Ave. North Eagle Farm,  
Brisbane QLD 4009 Australia

[www.fireflylighting.com.au](http://www.fireflylighting.com.au)

### Static Range

#### IC-GW-23

160 LEDs

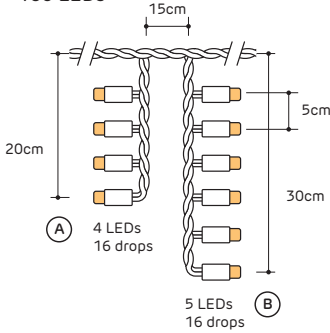

#### IC-GW-35

128 LEDs

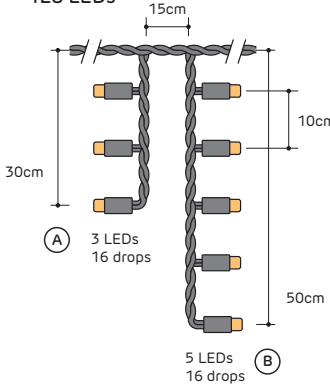

#### IC-GW-11

170 LEDs

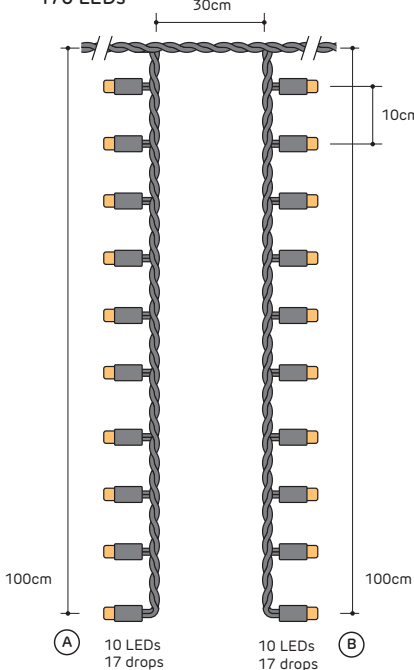

#### IC-GW-12

250 LEDs

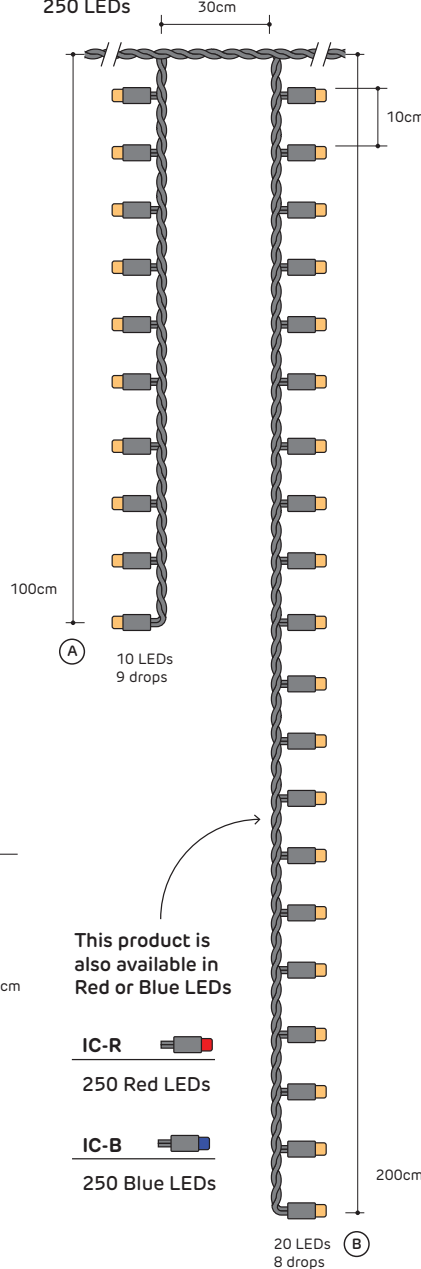

This product is also available in Red or Blue LEDs

- IC-R 250 Red LEDs
- IC-B 250 Blue LEDs

### Golden Warm White Static with Warm White and Cool White Glitter

#### IC-GW-3F

250 LEDs

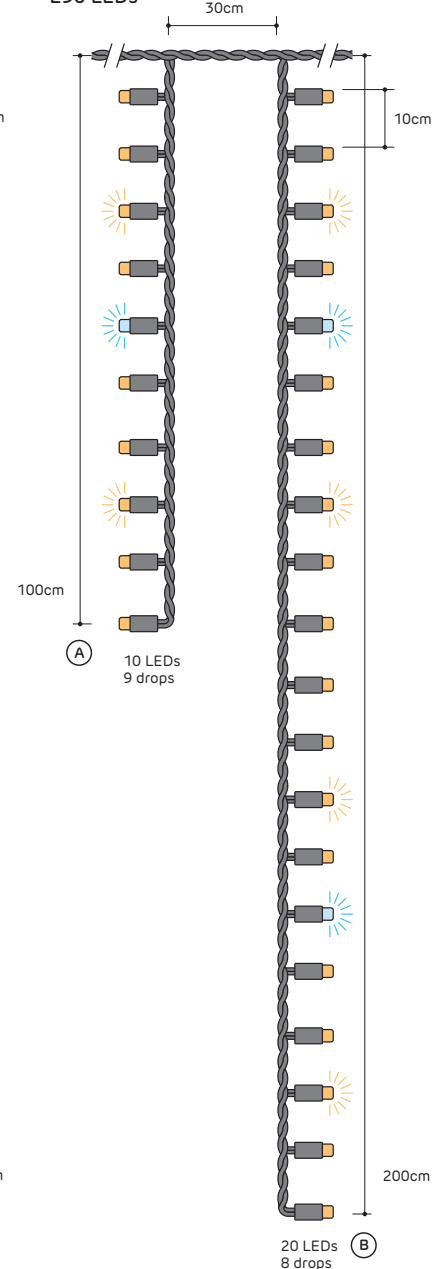

Firefly Icicle Lights are the ideal solution for many applications. String lengths are 5m. Simply connect and install. No need for cutting, soldering, or taping, saving you time and expensive labour costs.



# Quick Connect



**FIREFLY LIGHTING**

Phone : +61 7 3254 4333

Email : sales@fireflylighting.com.au

Address : 9/29 Links Ave. North Eagle Farm, Brisbane QLD 4009 Australia

[www.fireflylighting.com.au](http://www.fireflylighting.com.au)

## SYSTEM LAYOUT

### 24V LED FAIRY AND ICICLE LIGHTS

#### COMMERCIAL GRADE / QUICK CONNECT SYSTEM

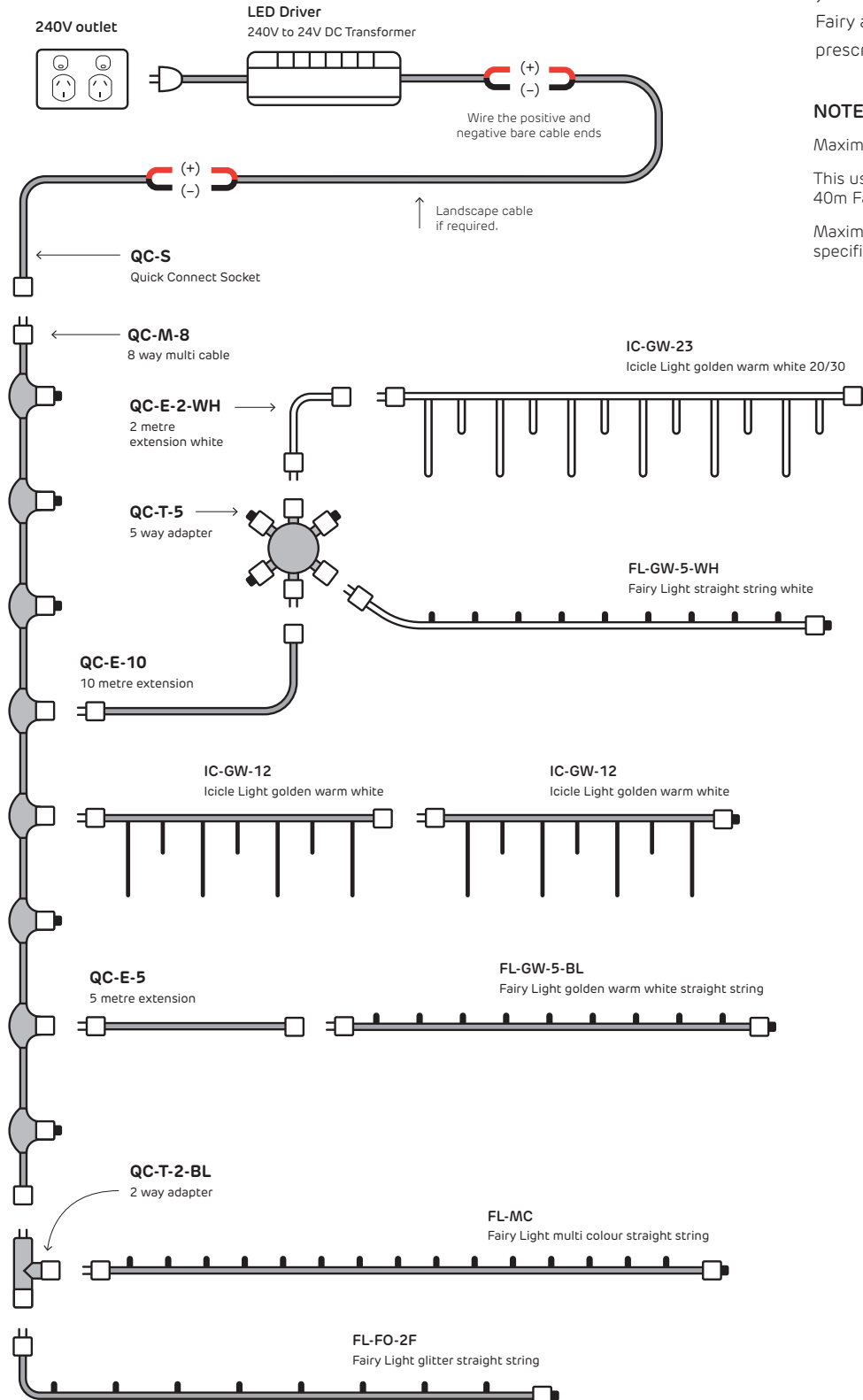

Firefly Lighting's Quick Connect System used across our Fairy Light and Icicle ranges allows you to easily connect additional strings of Fairy and Icicles lights in the same run within prescribed max run lengths.

## NOTES

Maximum cable length from the LED driver is 50m.

This usually consists of 10m extension cables and 40m Fairy Light straight strings.

Maximum connectable lengths noted on specification sheets.

## KEY

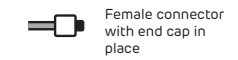
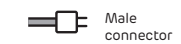

Ensure all bare end cables are finished off with resin filled heat shrink to ensure IP rating is maintained.

# Quick Connect



**FIREFLY LIGHTING**

Phone : +61 7 3254 4333

Email : sales@fireflylighting.com.au

Address : 9/29 Links Ave. North Eagle Farm, Brisbane QLD 4009 Australia

[www.fireflylighting.com.au](http://www.fireflylighting.com.au)

## SYSTEM ACCESSORIES

### 24V LED FAIRY AND ICICLE LIGHTS

#### COMMERCIAL GRADE / QUICK CONNECT SYSTEM

Firefly Lighting's Quick Connect System used across our Fairy Light and Icicle ranges allows you to easily connect additional strings of Fairy and Icicles lights in the same run within prescribed max run lengths.

Our simple plug n play system integrates polarity wiring and water proof connections into a easy to use scaleable solution.

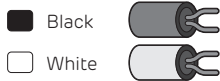

#### CABLE COLOUR

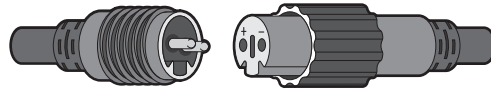

#### MALE CONNECTOR

2 prongs with positive and negative pre wired.

#### FEMALE CONNECTOR

Pushes into the male connector and screws tight to seal.

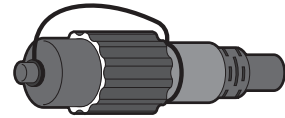

#### UNUSED CONNECTORS

Screw the end cap onto the end of the female connector to seal.

### QC-S

#### Quick Connect Socket

Connects the LED driver to the Firefly Quick Connect System.

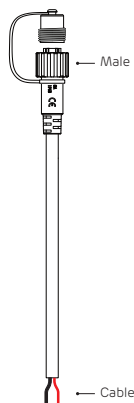
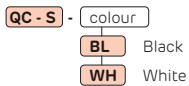

### QC-E

#### Quick Connect Extension Cable

Available in 2m, 5m and 10m lengths.

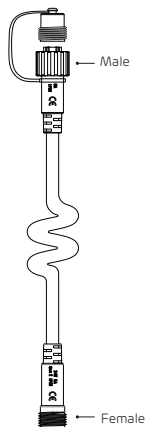
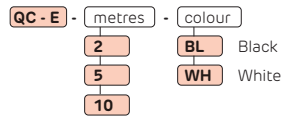

### QC-T-2

#### Quick Connect Adapters

Connect up to 50m of Firefly Fairy Lights from each output. Max 50m length from output taking into account any extension cables and tail length from LED driver.

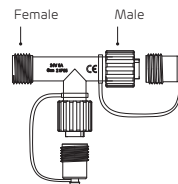
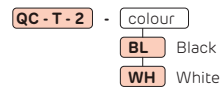

### QC-T-5

QC-T-5 Black

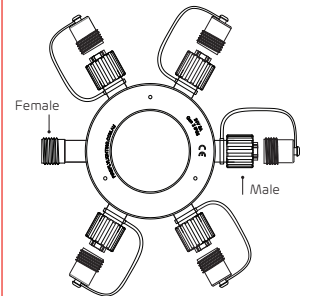

### QC-M

#### Quick Connect Multi Outlet cable

Connect up to 50m of Firefly Fairy Lights from each output. Max 50m length from output taking into account any extension cables and tail length from LED driver.

