

# LT-854-5A DMX/RDM CV Decoder



FC CE RoHS (warranty 5 years)

With the standard RDM (Remote Device Management) protocol, LT-854-5A supports DMX512 signal bi-directional communication, achieves remote management of reading and writing DMX addresses (DMX master controller must recognize the RDM protocol). It realizes 0-100% dimming or different lighting effects. It can work with DIM, CT, RGB, RGBW LED lamps.

## 1. Product Parameters:

### LT-854-5A

Input Signal:	DMX512, RDM	Protection:	Short circuit / Over load recover automatically
Input Voltage:	12-24Vdc	Working Temp.:	-30°C ~ 65°C
Current Load:	5A×4CH Max. 20A	Dimensions:	L175×W42×H33mm
Output Power:	{0~60W...120W}×4CH Max.480W	Package Size:	L183×W48×H41mm
DMX512 Socket:	Green Terminal	Weight(G.W.):	310g

## 2. Product Size:

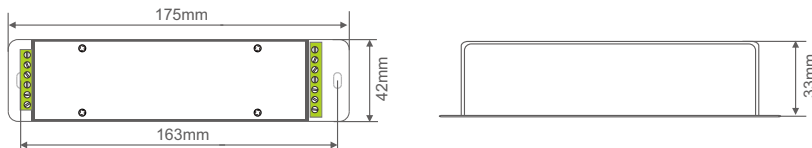

## 3. Dip Switch Operation:

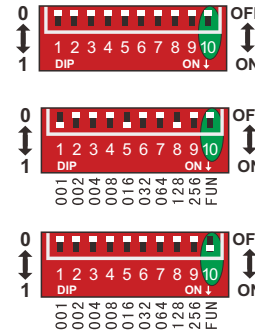

### 3.1 How to set DMX address via dip switch:

**FUN=OFF** (the 10th dip switch=OFF) **DMX Mode**

DMX address value = the total value of {1-9}, to get the place value when "on" position, otherwise will be 0.

E.g.1: Set Initial Address To 32.

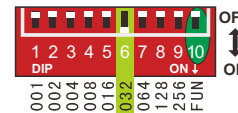

E.g.2: Set Initial Address To 37.

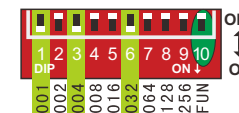

001+004+032=37

E.g.3: Set Initial Address To 178.



002+016+032+128=178

### 3.2 Self-testing Mode:

**FUN=ON** (the 10th dip switch=ON) **Self-testing Mode**

Dip Switch	1-9=OFF	1=ON	2=ON	3=ON	4=ON	5=ON	6=ON	7=ON	8=ON	9=ON
Self-testing Function	Static Black	Static Red	Static Green	Static Blue	Static Yellow	Static Purple	Static Cyan	Static White	7 Colors Jumping	7 Colors Smooth

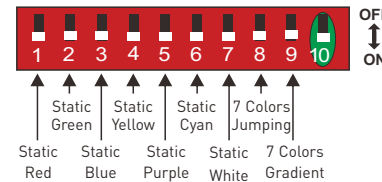

For changing effects (Dip Switch 8/9=ON):  
DIP switch 1-7 is used to realize 7 speed levels.  
(7=ON, the fastest level)

\* When several dip switches are ON, subjected to the highest switch value.  
As the figure above shows, the effect will be 7 colors gradient at 7 speed level.

4. Wiring Diagram:

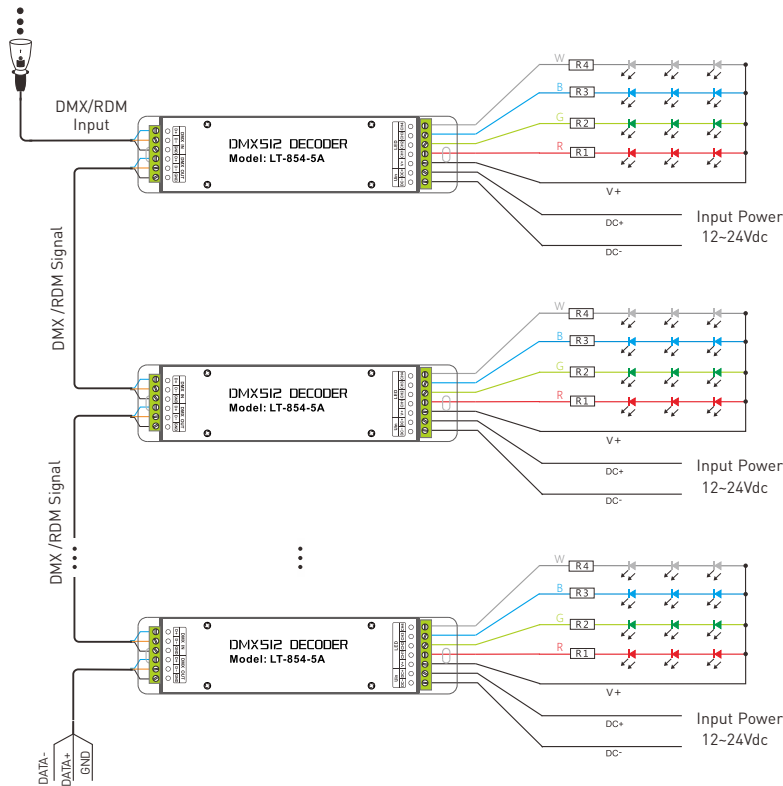

Terminal resistor  
1/4W,120Ω

\* When more than 32 DMX decoders are connected, DMX signal amplifiers are needed and signal amplification should not be more than 5 times continuously. If you need to modify the parameter settings of connected DMX/RDM decoders that exceed 32, you can add 1 RDM signal amplifier. Or you can add 1-5 DMX signal amplifiers after completing the parameter settings.

\* If the recoil effect occurs because of long signal line or poor quality wires, please try to connect 0.25W 90-120Ω terminal resistor at the end of each signal line.

5. Pluggable terminal block wiring diagram:



1.Pull the male terminals out of the terminal block.

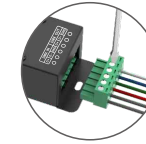

2. Connect the wires to the male terminals with a screwdriver as shown in the diagram

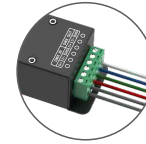

3.After wiring is completed, insert the male terminals into the female terminals of the terminal block

6. Attentions:

- This product must be installed and adjusted by a qualified professional.
- This product is non-waterproof (special models excepted). Please avoid the sun and rain. When installed outdoors, please ensure it is mounted in a water proof enclosure.
- Good heat dissipation will extend the life the product. Please install the product in a environment with good ventilation.
- When you install this product, please avoid being near a large area of metal objects or stacking them to prevent signal interference.
- Please keep the product away from a intense magnetic field, a high pressure area or a place where lightning is easy to occur.
- Please check whether the working voltage used complies with the parameter requirements of the product.
- Before you power on the product, please make sure all the wiring is correct in case of incorrect connection that may cause a short circuit and damage the components, or trigger a accident.
- If a fault occurs, please do not attempt to fix the product by yourself. If you have any question, please contact the supplier.

\* This manual is subject to changes without further notice. Product functions depend on the goods. Please feel free to contact our official distributors if you have any question.

7. Warranty Agreement:

Warranty periods from the date of delivery : 5 years.

Free repair or replacement services for quality problems are provided within warranty periods.

Warranty exclusions below:

- Beyond warranty periods.
- Any artificial damage caused by high voltage, overload, or improper operations.
- Products with severe physical damage.
- Damage caused by natural disasters and force majeure.
- Warranty labels and barcodes have been damaged.
- No any contract signed by LTECH.

1. Repair or replacement provided is the only remedy for customers. LTECH is not liable for any incidental or consequential damage unless it is within the law.

2. LTECH has the right to amend or adjust the terms of this warranty, and release in written form shall prevail.